

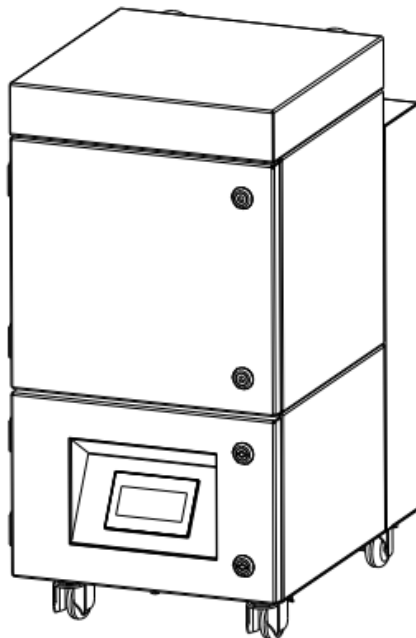

# Operating instructions

(Translation of the original operating instructions)

## TEKA - LMD 508



## Table of contents

<b>1. General</b>	<b>3</b>
<b>2. Description of the system elements</b>	<b>4</b>
2.1. Illustration of the system elements	4
2.2. Functionality of the system	5
2.3. Intended use	5
2.4. Residual risk	5
<b>3. Safety instructions</b>	<b>6</b>
3.1. Definition of the hazard symbols	6
3.2. General safety instructions	6
<b>4. Storage, transport and installation of the device</b>	<b>7</b>
<b>5. Commissioning</b>	<b>7</b>
5.1. Connecting an extraction element	8
5.2. Electrical connection	8
<b>6. Operating the system</b>	<b>9</b>
6.1. Explanation of the operating elements	9
6.2. Connection of an external control	9
<b>7. Maintenance</b>	<b>10</b>
7.1. Reset to maintenance state	11
7.2. Replacing the prefilter mat	11
7.3. Replacing the particle filter	12
7.4. Replacing the activated carbon / the activated carbon cassette	12
7.4.1. Replacing the activated carbon	13
7.4.2. Replacing the activated carbon cassette	15
<b>8. Dismantling / Disposal</b>	<b>15</b>
<b>9. Diagnostics and troubleshooting</b>	<b>16</b>
<b>10. List of spare parts</b>	<b>17</b>
<b>11. Technical data</b>	<b>18</b>
<b>12. EC declaration of conformity</b>	<b>19</b>
<b>13. Training protocol</b>	<b>20</b>
<b>14. Maintenance intervals</b>	<b>21</b>
14.1. Usage-related maintenance	21
14.2. General maintenance	21
14.2.1. Visual inspection of the device	22
14.2.2. Functional test of the device	22
14.2.3. Electrical test of the electrical lines and earthing connections	23

## 1. General

Congratulations on purchasing the product from TEKA.

Our engineers ensure that our devices reflect the state of the art through continuous development. Nevertheless, misuse or misconduct can endanger your safety. Please observe the following for a successful use of the device:

	<p>Only authorised and instructed personnel can carry out transport, operation, maintenance and repair of the device. The operator must ensure that the operating personnel take note of these instructions.</p> <p>Please read these instructions before operating the device, and observe the safety precautions to avoid injury!</p> <p>Store this manual in a safe place! These instructions are to be regarded as a component of the product!</p> <p>Adhere to all product notes!</p> <p>Modifications or conversions that the operator carries out at the device without the consent of the manufacturer, can lead to new safety hazards or to the loss of warranty claims.</p> <p>Observe the manufacturer's instructions. Contact the manufacturer in case of any uncertainty: Tel: +49 2541-84841-0 E-mail: info@teka.eu</p>
---	---

## 2. Description of the system elements

### 2.1. Illustration of the system elements

Installation example:

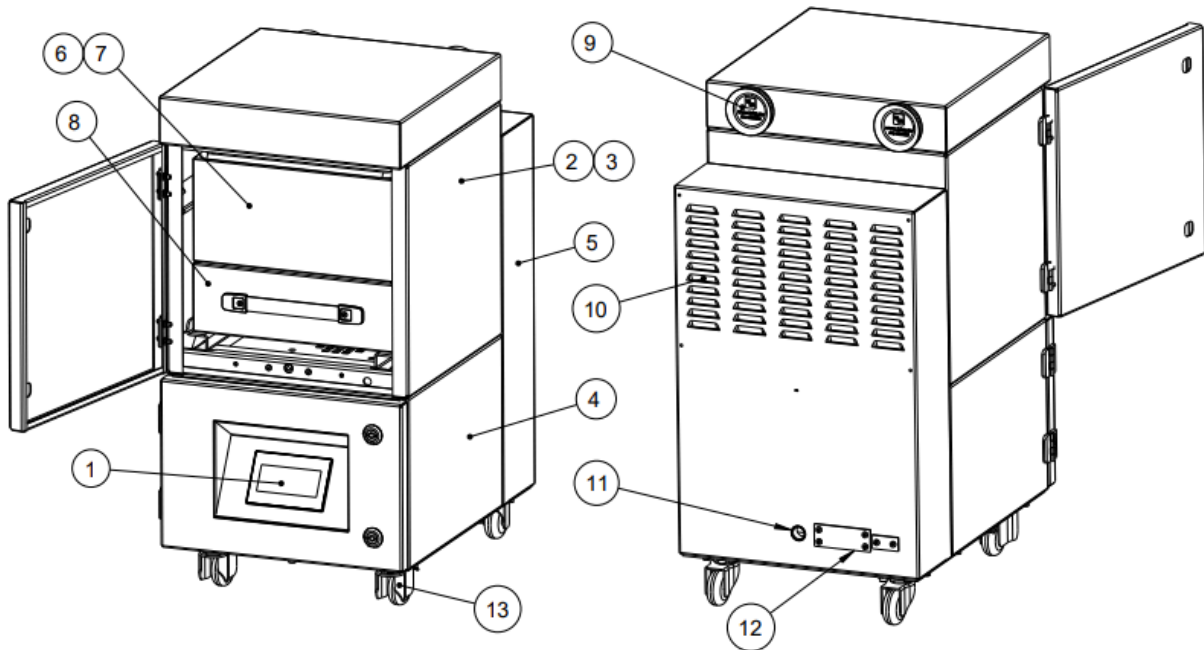

Z.Nr. 13153705

Pos.1	Operating panel of the control	Pos.8	Activated carbon cassette
Pos.2	Particle filter housing	Pos.9	Suction nozzle
Pos.3	Activated carbon housing	Pos.10	Exhaust grille
Pos.4	Turbine housing	Pos.11	Mains cable with plug
Pos.5	Silencing housing	Pos.12	Connection for external control unit
Pos.6	Particle filter	Pos.13	Swivel castor
Pos.7	Prefilter mat (inserted into particle filter)		

## 2.2. Functionality of the system

The filter unit serves to suck off and filter polluted air (according to the intended use). First of all, the coarse particles are separated at the prefilter mat in the filter section of the unit. The subsequent particle filter cleans even fine smokes and dusts. The activated carbon filter absorbs gases and unpleasant odours. An automatic filter monitoring indicates when a cleaning or a replacement of the filters is necessary. The purified air is led back into the working room.

## 2.3. Intended use

The device is intended for commercial use. If the device is made publicly accessible, it must never be operated unsupervised by authorized personnel, authorized by the operator.

The filter unit is intended for extraction and filtration of fumes that result from lasers or soldering jobs.

	<b>WARNING</b>
	<p><b>Improper use can damage parts and be a danger to life and limb!</b> The device must not be used for the extraction of oil-laden welding fume, explosive dust and gases, hybrid mixtures, glowing or burning substances, gases, water, etc. The device must not be operated in explosive zones.</p> <hr/> <p><b>Dangers arising from fire.</b> If the sucked medium is combustible fume or dust, the operator must determine beforehand which fire protection measures are to be taken.</p>

## 2.4. Residual risk

	<b>CAUTION</b>
	<p><b>Danger due to possible hazardous materials in the exhaust air flow.</b> Because the unit does not monitor the quality of the air in the exhaust air flow, we recommend that you always guide the exhaust air flow exiting our unit to areas (e.g. to the outside into the open air) in which there is no danger to any living being. To do this, it is necessary to fit a suitable exhaust air line at the filter unit.</p>

### 3. Safety instructions

#### 3.1. Definition of the hazard symbols

The device is constructed according to the state of the art and the recognised safety regulations. Nevertheless, during use threats to life and limb of the user or other persons may arise. The impairment of the machine or other property are also possible. In these instructions we warn by using corresponding indications.

	<b>WARNING</b>
	<p><b>WARNING</b> These instructions are made in case of risks that can lead to <u>injury or death</u>.</p>

	<b>CAUTION</b>
	<p><b>CAUTION</b> These instructions are made in case of risks that can lead to <u>injury</u>.</p>

	<b>NOTICE</b>
	<p><b>NOTICE</b> These instructions are made in case of risks that can lead to <u>material damages</u>.</p>

	Information notes are no hazard warnings; they call attention to useful information.
---	--

#### 3.2. General safety instructions

	<b>WARNING</b>
	<p><b>Dangers arising from improper use / unauthorised operations.</b> The operator must ensure that their authorised personnel are familiar with all the safety indications in this manual in advance. The operator is responsible for ensuring that all work is carried out by authorised and qualified personnel. We therefore recommend using the training protocol on the last page for that purpose (see chapter "Training protocol"). Laymen are allowed to operate the device after having received the necessary instructions. But they are not allowed to carry out any installation, repair or maintenance work.</p> <hr/> <p><b>Dangers arising from fire.</b> In case of fire, if possible, switch the unit immediately off or disconnect it from the power supply. Fire extinguishing measures which the operator is obliged to determine beforehand must be initiated immediately.</p>

	<b>WARNING</b>
	<p><b>Dangers arising from electricity.</b> The operator must ensure that electrical plants and equipment are only built, modified and maintained by a qualified electrician or under the direction and supervision of a qualified electrician. Do not work on components if you are not sure that these are disconnected. If necessary, disconnect the device from the electric power supply and secure it against unauthorized restarting.</p>

## 4. Storage, transport and installation of the device

	<b>WARNING</b>
	<p><b>Risk of injury from tilting or unmounted components when stored or transported.</b> The device must be secured against tilting and slipping when it is stored or transported. Do not stand under or next to the floating load. Lift trucks, forklift trucks and transport cranes must have a sufficient minimum load bearing capacity. Pay attention to uneven grounds during the transport. Avoid jerky pushing.</p> <hr/> <p><b>Dangers arising from tilting or functional impairments at its destination.</b> The unit may only be set up on a suitable surface. The surface must be vibration-free and horizontal. The operator must check the bearing capacity of the surface. As soon as the unit has reached its intended destination, the brakes of the castors must be activated.</p>

	<b>NOTICE</b>
	<p><b>Damage or functional impairment of the unit due to climatic influences.</b> The unit must be stored in a dry place and protected against moisture during transport. As a matter of principle, the filter unit is not designed to be installed outside.</p>

## 5. Commissioning

	<b>WARNING</b>
	<p><b>Dangers arising from a defective condition of the unit.</b> Make sure that the measures described in this chapter are completed before the commissioning of the unit. All doors of the unit must be closed and all necessary connections must be attached before turning the unit on. Do not operate the unit if any components are defective, missing or damaged. Check the orderly condition of the unit before switching it on. The unit must not be operated without a filter element.</p>

	<b>NOTICE</b>
	<p><b>Damaged supply lines.</b> Make sure that the supply lines are protected against damage by forklift trucks and similar events. Protect all supply lines from heat, moisture, oil and sharp edges.</p>

## 5.1. Connecting an extraction element

For extracting the contaminated air - according to the intended use - the provided extraction element (e.g. suction arm, suction hose, ...) must be connected at the suction nozzle (see chapter 2.1).

## 5.2. Electrical connection



### NOTICE

**Electric malfunction possible in cause of an incorrect power supply.**

Pay attention to the admissible supply voltage. Please observe the specifications on the type plate.

- Reconnect the mains cable (see chapter 2.1) to the power supply.



## 6. Operating the system

### 6.1. Explanation of the operating elements

 Control functions, setting options for programs, menu navigation, error messages, etc. are described in the enclosed operating manual of the unit control. There is also an explanation of the elements of the control panel.

### 6.2. Connection of an external control

There is the possibility to control the unit from extern. For this purpose, a connection is provided on the unit (see chapter 2.1).

Connection plug type:	<b>“Sub-D9”</b>
Number of pins:	<b>9</b>

Pin-Nr.	Designation	Explanation
<b>1, 2</b>	Start contact	In order to switch on the filter unit, a contact has to be connected between pin 1 and pin 2. The unit is switched out when the contact is opened.  When the follow-up time is activated, the unit switches off after the preset period of time.
<b>3, 4</b>	External message “Operation”	Pin serves for the evaluation of the operational control. (NO: normaly open)
<b>5, 6</b>	External message “Fault”	Pin serves for the evaluation of an fault indication. (NO: normaly open)
<b>7</b>	Increase of the speed of the turbine (option)	In order to increase the performance of the turbine, a contact has to be connected between pin 7 and pin 1. (optional, and only for units with up to 2 x 1,2kW turbines)
<b>8</b>	Reducing of the speed of the turbine (option)	In order to reduce the performance of the turbine, a contact has to be connected between pin 8 and pin 1. (optional, and only for units with up to 2 x 1,2kW turbines)

## 7. Maintenance

In accordance with national regulations, the operator is obliged to carry out repeat and functional tests. Unless otherwise specified by national regulations, we recommend regular visual inspections and functional tests of the device as described in the chapter "Maintenance intervals".



You find the chapter "Maintenance intervals" at the end of the document. The general maintenance (visual inspection, etc.) is also explained there.

In the chapter "Maintenance intervals" there is information on the maintenance intervals of the filter elements. But these are only recommendations. Depending on the application (multi-shift operation, dust generation, ...) it may be necessary for the operator to change the maintenance intervals.

In this chapter the maintenance work which is caused by wear caused during operation is described.



### WARNING

**Work on the open system entails the risk of electrical shock or accidental restart the system. Both pose a danger to life and limb.**

When cleaning and servicing equipment during the replacement of parts or when changing to another function, set the device to maintenance condition first (see chapter "Reset to maintenance state").

A recommissioning of the device must only occur if it is ensured that the device is functionally equivalent to the original state.

### Dangers to life and limb when non-original spare parts are used

Only original TEKA spare parts must be used.



### CAUTION

**Hazards to the respiratory tracts are possible due to contact with contaminated filter elements.**

All maintenance work must only be carried out in well-ventilated rooms and while wearing an appropriate respiratory mask! We recommend: respiratory protection half mask DIN EN 141/143 protection level P3. For all maintenance work ensure a cautious handling of filter elements and components in order to avoid whirling up dust.



The operator is obliged to store and dispose of the collected dust in accordance with national or regional regulations. For all maintenance or cleaning work please refer to the applying environmental regulations. Pollutants and filter elements must be disposed of or stored according to the regulations as well. If you have any doubts, we recommend contacting a disposal contractor in your area.

## 7.1. Reset to maintenance state

- Switch off the unit. Unplug the mains plug. Secure the unit against unauthorized restarting during maintenance.
- After completion of all maintenance work the unit can be reconnected to the power supply.

## 7.2. Replacing the prefilter mat

The prefilter mat is installed upstream to the particle filter and separates the coarse particles. This extends the service life of the particle filter.

The prefilter mat must be changed after a certain number of operating hours. The time depends on the amount of accumulated dust, and therefore cannot be determined beforehand. At the latest, the prefilter mat must be changed when changing the particle filter.

	<b>CAUTION</b>
<b>Whirling up dust is possible.</b> The prefilter mat is a disposable filter element. Do not try to clean the filter element.	

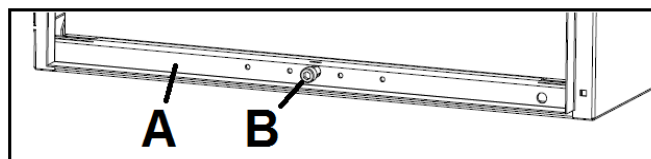

- Open the service door of the particle filter housing (see chapter 2.1).
- Lower the lifting device (A) by turning the clamping screw (B). Therefore, use the hexagon key that is located on the right of the clamping screw.
- Carefully pull the particle filter (see chapter 2.1) out of the housing.
- Remove the prefilter mat from the particle filter and dispose of or store it according to the regulations.
- Put a new prefilter mat into the particle filter.  
**NOTICE** Only use TEKA spare filters. Otherwise the proper functioning of the unit is not guaranteed, and there is a danger to life and limb.
- Push the particle filter back into the particle filter housing as far as it will go.
- Elevate the lifting device by turning the clamping screw so that the particle filter is pressed tightly against the above housing.
- Close the service door.

### 7.3. Replacing the particle filter

Replacing the particle filter is necessary when the device control signals the corresponding error. (see chapter "Description of the control elements")



#### CAUTION

**Whirling up dust is possible.**

The particle filter is a disposable filter element. Do not try to clean the filter element.



When replacing the particle filter, the prefilter mat must be replaced as well.

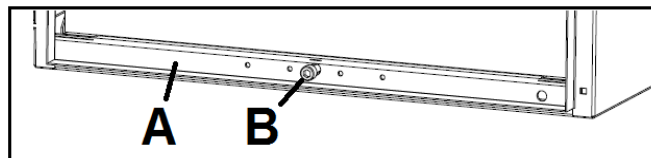

- Open the service door of the particle filter housing (see chapter 2.1).
- Lower the lifting device (A) by turning the clamping screw (B). Therefore, use the hexagon key that is located on the right of the clamping screw.
- Carefully pull the particle filter (see chapter 2.1) out of the housing.
- Push the new particle filter back into the particle filter housing as far as it will go.  
**NOTICE** Only use TEKA spare filters. Otherwise the proper functioning of the unit is not guaranteed, and there is a danger to life and limb.
- Elevate the lifting device by turning the clamping screw so that the particle filter is pressed tightly against the above housing.
- Close the service door.

### 7.4. Replacing the activated carbon / the activated carbon cassette

The activated carbon absorbs gases and unpleasant odours. The activated carbon has to be replaced as soon as gases appear on the clean air side.





However, at the latest when the main filter of the device is replaced, the activated carbon should be replaced as well. For it is also the pollution of the activated carbon which lowers the (entire) extraction capacity of the filter unit.

Therefore, replace the activated carbon in the activated carbon cassette. Alternatively, you can replace the entire activated carbon cassette. Different spare parts are required for these two options (see list of spare parts).

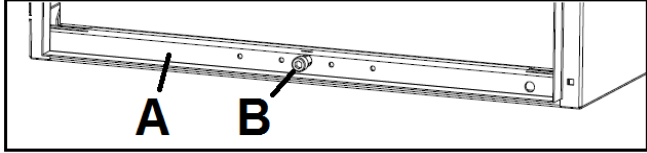

The saturation degree of the activated carbon is not monitored.

### 7.4.1. Replacing the activated carbon

<ul style="list-style-type: none"> <li>• Open the service door of the activated carbon housing (see chapter 2.1).</li> <li>• Lower the lifting device (A) by turning the clamping screw (B). Therefore, use the hexagon key that is located on the right of the clamping screw.</li> <li>• Carefully pull the entire filter pack, incl. the activated carbon cassette (see chapter 2.1), out of the housing.</li> </ul>	
<ul style="list-style-type: none"> <li>• Remove the cover of the activated carbon cassette. To do this, it is necessary to undo the screws. <i>(The activated carbon cassette shown in the illustration may possibly be of a different size to the one installed in your filter unit. However, the principle is identical.)</i></li> <li>• Remove the top filter fleece mat.</li> </ul>	
<ul style="list-style-type: none"> <li>• Carefully empty the activated carbon. The used activated carbon must be emptied into an appropriate container and disposed of.</li> </ul>	
<ul style="list-style-type: none"> <li>• Remove the bottom filter fleece mat.</li> <li>• Insert the new filter fleece mat here. This must completely cover the holes in the grille at the base.</li> </ul>	

<ul style="list-style-type: none"> <li>The new activated carbon must be carefully filled into the activated carbon cassette. Gradually fill with a number of smaller quantities of activated carbon, spreading it out evenly and gently pressing down on it as you do so.</li> </ul> <p><b>NOTICE</b> Only use TEKA spare filters. Otherwise the proper functioning of the unit is not guaranteed, and there is a danger to life and limb.</p>	 
<ul style="list-style-type: none"> <li>The cassette must be filled with activated carbon up to the height of the support surface (A) and levelled off.</li> <li>Place the new top filter fleece mat over the activated carbon. It may be necessary to cut the filter fleece mat to the right size. The size must correspond to the dimensions of the cover.</li> </ul>	
<ul style="list-style-type: none"> <li>Screw the cover back on again. When you do this, the cover must press the top filter fleece mat against the support surface of the activated carbon cassette all the way round.</li> </ul>	
<ul style="list-style-type: none"> <li>Push the filter pack back into the filter housing. Make sure that the filter elements are inserted in the correct order.</li> <li>Elevate the lifting device by turning the clamping screw so that the entire filter pack is pressed tightly against the above housing.</li> <li>Close the service door.</li> </ul>	

#### 7.4.2. Replacing the activated carbon cassette

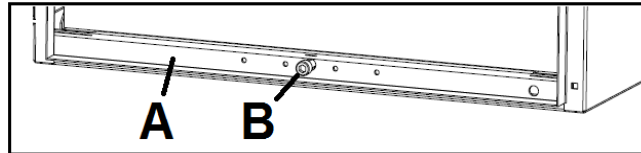



- Open the service door of the activated carbon housing (see chapter 2.1).
- Lower the lifting device (A) by turning the clamping screw (B). Therefore, use the hexagon key that is located on the right of the clamping screw.
- Carefully pull the entire filter pack, incl. the activated carbon cassette (see chapter 2.1), out of the housing. (If a spacer frame is mounted in addition, it must be carefully removed as well.)
- Replace the activated carbon cassette.  
**NOTICE** Only use TEKA spare filters. Otherwise the proper functioning of the unit is not guaranteed, and there is a danger to life and limb.
- Push the filter pack back into the filter housing. Make sure that the filter elements are inserted in the correct order.
- Elevate the lifting device by turning the clamping screw so that the entire filter pack is pressed tightly against the above housing.
- Close the service door.

## 8. Dismantling / Disposal

Only authorised personnel may disassemble the machine.

	<b>WARNING</b> <b>Dangers arising from electricity.</b> Before the dismantling of the machine it has to be disconnected from the power supply and all supply lines.
---	---

	<b>CAUTION</b> <b>Whirling up dust is possible due to the deposited dust.</b> During all work a suitable respiratory protection and protective clothing have to be worn.
---	--

	The operator is obliged to store and dispose of the collected dust in accordance with national or regional regulations.
---	---

## 9. Diagnostics and troubleshooting

A list of possible system errors is provided in the table.



Error messages of the control unit are described in the enclosed operating manual of the control unit.

A recommissioning of the device must only occur if it is ensured that the system is functionally equivalent to the original state. Repairs may only be carried out by TEKA personnel or, after consultation with TEKA GmbH, by the personnel authorised by the operator.

Adhere to the instructions in the chapter "Safety instructions" and "Maintenance" when carrying out any repairs. If in doubt, contact our TEKA service department:

Tel: +49 2541-84841-0  
E-mail: info@teka.eu

Fault	Cause	Removal
System does not start.	Plug power supply is missing or incorrectly inserted.	Plug connector check power supply / plug in correctly.
	No power at outlet.	Check the mains, remove error if possible.
Suction power too low (smoke hardly extracted).	Filter element is saturated.	Replace the filter package, dispose of old filter properly!
	Damage at the extraction elements.	Replace the extraction elements.
	Suction line contracted.	Check and fix.
	Exhaust line contracted.	Check and fix.



## 10. List of spare parts

	<b>WARNING</b>
	<b>Dangers to life and limb when non-original spare parts are used.</b> Only original TEKA spare parts must be used.

Filter element	Article no.
Prefilter mat "M5" (10 pieces / 268 x 268 x 20 mm)	10033
Particle filter "H13" (305x305x150)	10031
Activated carbon cassette, 3,5 kg activated carbon (305 x 305 x 100) <b>or:</b> 3,5 kg activated carbon, including filter fleece mats	97054  100197507

## 11. Technical data

Supply voltage	V	230
Frequency	Hz	50 / 60
Type of current	Ph	1
engine power	kW	1,2
Air flow volume max.	m³/h	320
Negative pressure max.	Pa	15000
Protection class		IP54
ISO class		F
Extraction performance	%	>99
Width	mm	365
Depth	mm	496
Height	mm	737
Weight	kg	55
Sound pressure level	dB(A)	65
Allowed ambient temperature	°C	+5 to +35 (during operations) -10 to +40 (during transport and storage)
Max. temperature of polluted air at the capture point	°C	+50
Allowed max. humidity	%	70

## 12. EC declaration of conformity

*according to the Machinery Directive 2006/42/EG, Annex II, 1 A*

TEKA Absaug- und Entsorgungstechnologie GmbH

Millenkamp 9, D-48653 Coesfeld

Tel.: +49 2541-84841-0

E-Mail: [info@teka.eu](mailto:info@teka.eu)

Internet: [www.teka.eu](http://www.teka.eu)

Designation of the device: TEKA - LMD 508

We hereby declare under our sole responsibility that the product mentioned above, from the serial number A22600010011001 resp. P57300010011001 on, conforms to the following directives:

**Machinery Directive:** 2006/42/EG

**Electromagnetic Compatibility:** 2014/30/EU

**RoHS directive:** 2011/65/EU

This declaration will become void if the device is exposed to modifications that are not approved by the manufacturer in written form.

Authorized representative for the technical documentation:

TEKA Absaug- und Entsorgungstechnologie GmbH, Millenkamp 9, D-48653 Coesfeld

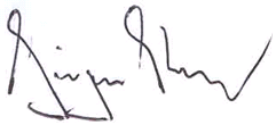

*(Jürgen Kemper, managing director)*

Coesfeld, 3rd january 2023



### 13. Training protocol

Designation of the device: TEKA - LMD 508

*(This form can be used by the operator to document the training of the employees. Training should be performed by authorized personnel only. Refer to the instructions in Chapter "Safety Instructions")*

By his signature, the employee confirms that he has been instructed regarding the following items:

Instruction	completed
Description of the device	
Operation and application of the device	
Explanation of the safety instructions	
Behavior in case of fire	
Explanation of the operation elements	
Change and dedusting of the filter elements	
Appropriate disposal	
Maintenance works / Maintenance intervals	

Name of the employee (legible)	Signature

Introduction through (legible):	
Signature:	

## 14. Maintenance intervals

### 14.1. Usage-related maintenance

The described maintenances become necessary through the demands of the system operations. The maintenance intervals are recommendations. Depending on the application (multi-shift operation, dust generation, ...) it may make sense for the operator to change the intervals of maintenance, replacing and cleaning.

Maintenance work must always be documented by means of a protocol.

The approach of the maintenance measures is described in chapter "Maintenance".

Maintenance work	Chapter	Maintenance interval	
		recommended by TEKA	determined by the operator
Replacing the particle filter	7.3	The saturation of the particle filter is automatically monitored by the filter unit and thus is not subject to a maintenance interval. The filter unit triggers an alarm when a replacement of the particle filter is necessary.	
Replacing the activated carbon / the activated carbon cassette (or check the degree of pollution)	7.4	when odours occur / when replacing the main filter	
Replacing the prefilter mat (or check the degree of pollution)	7.2	monthly	

### 14.2. General maintenance

The described maintenances are independent from the demands of the system operations.

The operator is obliged to carry out repeated inspections and functional tests according to national regulations. If not otherwise covered by national regulations, the described maintenance intervals must be respected.

Maintenance work must always be documented by means of a protocol.

Maintenance work	Chapter	Maintenance interval
<b>Visual</b> inspection of the device	14.2.1	weekly
<b>Functional</b> test of the device	14.2.2	monthly
<b>Electrical</b> test of the electrical lines and earthing connections	14.2.3	annually

### 14.2.1. Visual inspection of the device

**Visual inspection:** Observation that there are no visible safety-related defects.

	<b>WARNING</b>
<b>Danger arising from the ready to operate condition of the device.</b> Follow the procedure as described in the chapter "Set to maintenance state".	

The following steps must be carried out in the course of the visual inspection:

- Check if all required pipeline elements, cable connections and hoses are connected to the filter unit
- Check all electrical earthing connections and cables for visible damages.
- Ensure that all parts are firmly connected.
- Check all connection points of the filter unit for escaping dust.
- Check all metal parts for corrosion or damages / changes of the coating.
- Check the inner filter area and the filter housing.
- Visual inspection of the control and operating elements as well as the outside running cables for damages.

### 14.2.2. Functional test of the device

	<b>NOTICE</b>
<b>Possible material damage due to faulty condition of the unit.</b> Carry out a visual inspection before the functional test of the device as described in the previous chapters. The work as described in the chapter "Commissioning" must be finished.	

The following steps must be carried out in the course of the functional test:

- Switch on the device.
- Pay attention to failures or error messages of the control unit. Also refer the separated operating manual of the control unit.
- Pay attention to extraneous noises or vibrations during the device's operation.
- A functional test should always be carried out with a connected / producing machine tool. Check if the collection of the fume or dust is sufficient. (Visual inspection).

### 14.2.3. Electrical test of the electrical lines and earthing connections

	<b>WARNING</b>
<b>Danger arising from electricity.</b> The operator is responsible for ensuring that all work on electric components is carried out by authorised and qualified personnel.	

The device is subject to regular electrical checks by the operator of the device, and are subject to national standards of the different countries.

The here recommended maintenance interval complies with the in Germany applying "Regulation 3 of the German Social Accident Insurance - Electrical plants and equipment" (formerly known as BGV-A3).

The check must only be carried out by a qualified electrician or a person trained in electrics using suitable measuring and test devices. The scope of testing and the methods must be in line with the respective national standard. All contacts in the control cabinet must be checked for tight fit, and must be readjusted if necessary.